

Box Style Reference

The following box styles are grouped in categories: (1) Slotted Boxes, (2) Telescope Boxes, (3) Folders, (4) Rigid Boxes (Bliss Boxes), (5) Self-Erecting Boxes, and (6) Interior Forms.

1. Slotted Boxes

Slotted box styles are generally made from one piece of corrugated or solid fiberboard. The blank is scored and slotted to permit folding. The box manufacturer forms a joint at the point where one side panel and one end panel are brought together. Boxes are then shipped flat to the user. When the box is needed, the box user squares up the box, inserts product and closes the flaps. The International Fibreboard Casecode refers to these styles as Slotted-Type Boxes, while the carrier classifications call them Conventional Slotted Boxes.



0200 Half Slotted Carton (HSC)
Same as Regular Slotted Carton (0201) without one set of flaps.

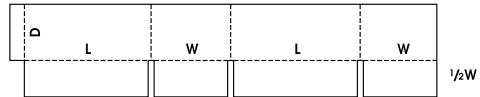

0201 Regular Slotted Carton (RSC)

All flaps have the same length, and the two outer flaps (normally the lengthwise flaps) are one-half the container width, so that they meet at the center of the box when folded. If the product requires a flat, even bottom surface, or the protection of two layers, a fill-in pad can be placed between the two inner flaps.

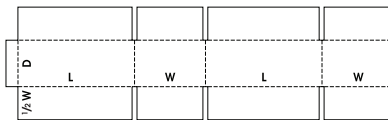
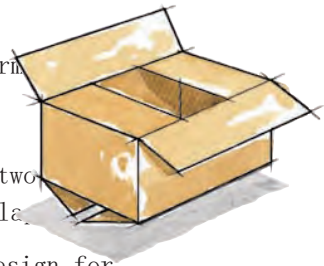

This is a highly efficient design for many applications. There is very little manufacturing waste. The RSC can be used for most products and is the most common box style.

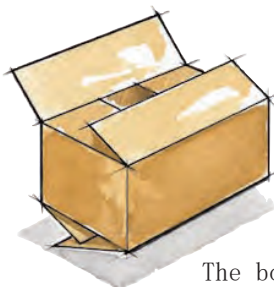

0202 Overlap Slotted Carton (OSC)
All flaps have the same length. The outer flaps overlap by one inch or more.

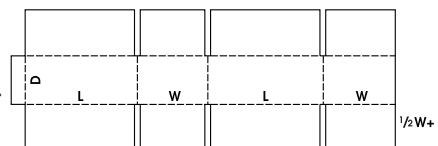

The box is easily closed, usually with staples driven through the overlap area.

This style is used when the length of the box is considerably greater than the width, resulting in a long gap between the inner flaps. The sealed overlap helps to keep the outer flaps from pulling apart.

Box Style Reference



0203 Full Overlap Slotted Carton (FOL)

All flaps have the same length (the width of the box). When closed, the outer flaps come within one inch of complete overlap.

The style is especially resistant to rough handling. Stacked on its bottom panel, the overlapping flaps provide added cushioning. Stacked on its side, the extra thickness provides added stacking strength.

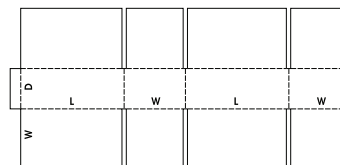

0204 Center Special Slotted Carton (CSSC)

Inner and outer flaps are cut to different lengths. Both pairs of flaps meet at the center of the box.

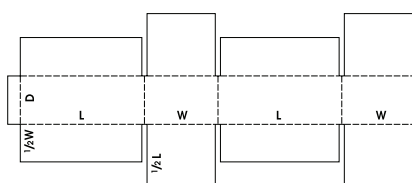
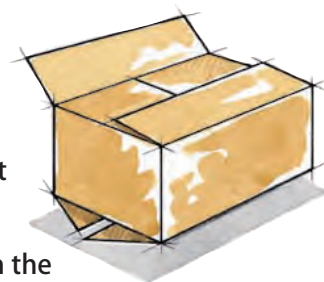

The style is especially strong because both the top and bottom have double the thickness of corrugated board. The inner flaps, with no gap, provide a level base for the product.

A variation of this box is the Side Special Slotted Carton, or SSS. All pairs of flaps meet, but not at the center of the box.



0205 Center Special Overlap Slotted Carton (CSO)

All flaps have the same length (one-half the length of the box). The length of the box can be no more than twice its width.

When closed, the inner flaps meet at the center of the box, providing a level base and full top protection. Depending on the ratio of length to width, the outer flaps overlap at random, up to full overlap.

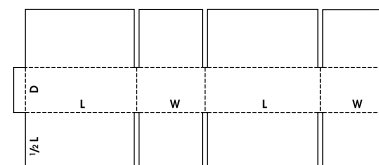

0206 Center Special Full Overlap Slotted Carton (SFF)

Inner and outer flaps are cut to different lengths. When closed, the inner flaps meet at the center of the box, and outer flaps fully overlap.

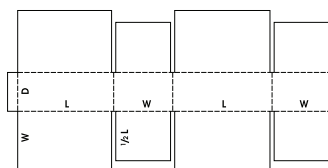
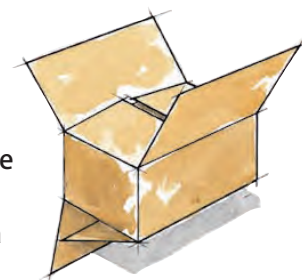

With three full layers of combined board over the entire top and bottom, this style provides extra cushioning when stacked on its bottom, or extra stacking strength when stacked on its side.

Box Style Reference



0215 Snap or 1-2-3 Bottom Carton with Tuck Top

The four flaps that form the bottom panel are die cut. To set up, the user folds the largest bottom panel first, then the two end panels. When the remaining bottom panel is folded and pressure is applied near the center, the flap “snaps” into the slot created by the other panels.

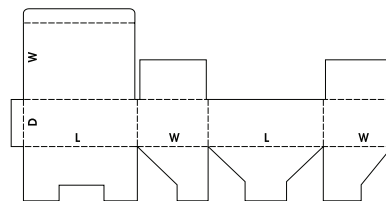

The style is convenient for small-volume shippers who do not have automatic set-up equipment. Because the bottom is not fully sealed, it may not be suitable for heavy products.

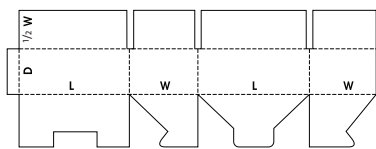

0216 Snap or 1-2-3 Bottom Carton with RSC Top

Same as 0215, replacing the tuck top configuration with RSC style flaps.



0225 Full Bottom File Box, Hamper Style, Ft. Wayne Bottom, or Anderson Lock Bottom

When set up, this box provides an interlocking thickness on its bottom and on its end panels.

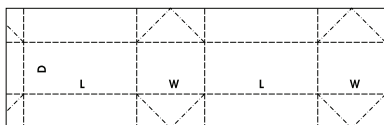
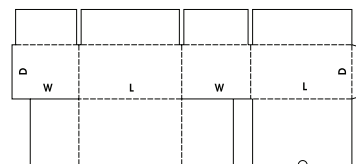

0226 Bellows Style Top and Bottom Carton

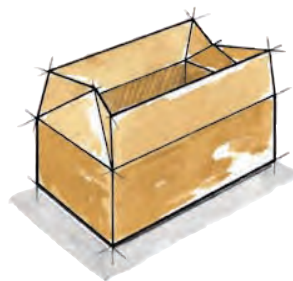

0228 Integral Divider Carton RSC with Internal Divider or Self Divider Box

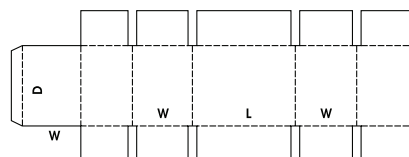

Box Style Reference

2. Telescope Boxes

Telescope boxes usually consist of a separate top, or top and bottom that fit over each other or a separate body. The International Fibreboard Casecode calls these boxes Telescope-Style. The truck and rail classifications call them Telescope Boxes if the cover extends over at least two-thirds of the depth, and Boxes with Covers if the cover extends over less than two-thirds of the depth.

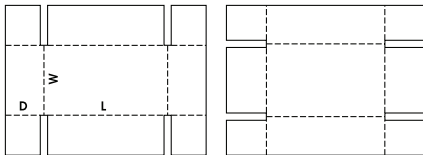

0301 "SS" , 0301 "ES" Trays, Design Style

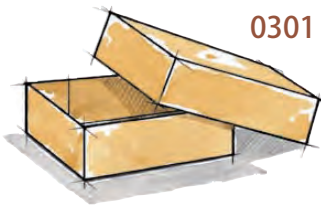

0301 Full Telescope Design Style Carton (FTD)

The two-piece box is made from two scored and slotted blanks (trays).

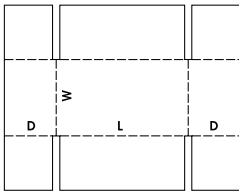
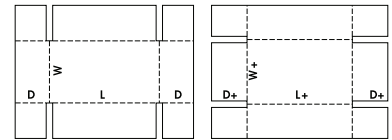

0306 Design Style Carton with Cover (DSC)

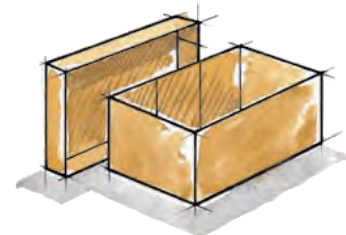

0310 Double Cover Carton (DC)

A tube forms the body. The two interchangeable covers are usually design style. The pieces are shipped flat to the user, who opens the tube and sets up the covers.

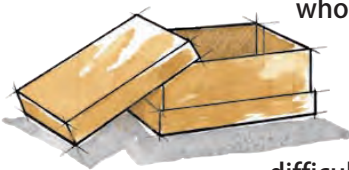

The style is frequently used for tall or heavy products that would be difficult to lower into a box. The item is placed on the bottom cover, and the tube is lowered over the product.

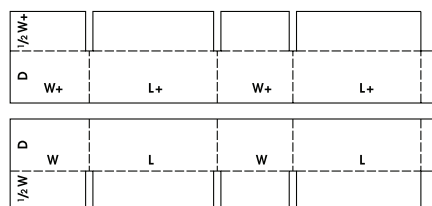
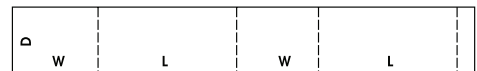
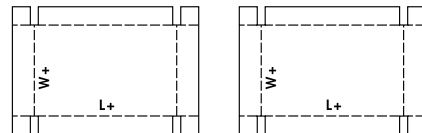

0320 Full Telescope Half Slotted Carton (FTHS)

The two-piece body is made from two half-slotted containers.



Box Style Reference



0325 Interlocking Double Cover Carton (IC)

Flanges on the body, folded together (interlocked/baseloid) with flanges on the covers, are held in place with strapping.

The style offers the same ease of packing provided by the double-cover box, with the assurance that the covers will not separate from the body. This feature is advantageous for moving large or heavy products such as washers, dryers, refrigerators, water heaters, vending machines and some hazardous materials.

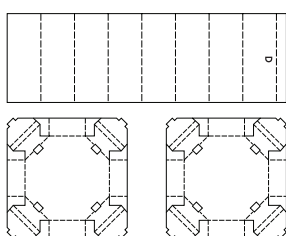
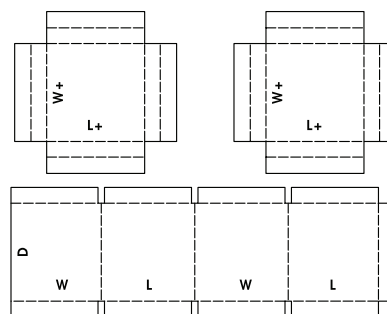

0351 Octagonal Double Cover Carton

Same as 0310 with additional panels.



3. Folders

For folders, one or more pieces of combined board provide an unbroken bottom surface, and are scored to fold around a product. The International Fibreboard Casecode describes them as Folder-Type Boxes. The carrier classifications use the term Folders.



0401 One Piece Folder (OPF)

One piece of board is cut so that it provides a flat bottom, with flaps forming the sides and ends, and extensions of the side flaps meeting to form the top.

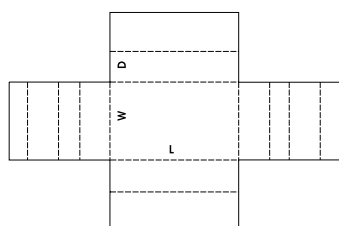
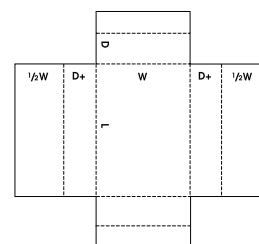

0403 One Piece Folder with Air Cell/End Buffers, Protect All or Bookwrap

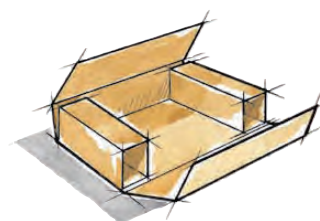

Box Style Reference

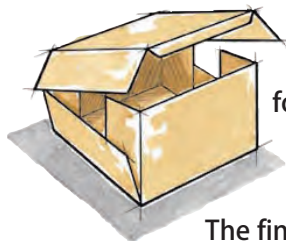

0406 Wrap Around Blank

A wrap-around blank is formed into a box by folding it tightly around a rigid product. The positioning of the product, folding and sealing are performed by automatic equipment.

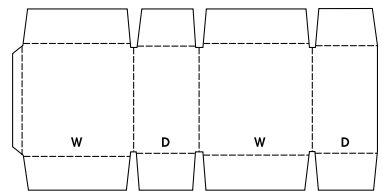

The finished box is essentially an RSC, turned on its side so that the bottom and top are unbroken. The joint, however, is not formed until the final closure.

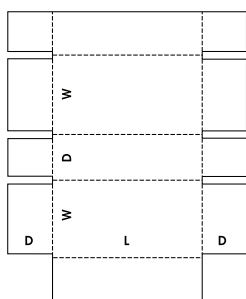

0410 Five Panel Folder (FPF) or Harness Style Five Panel Folder

A single cut and scored piece features a fifth panel used as the closing flap, completely covering a side panel. The closed box has several layers of combined board on each end, providing stacking strength and protection for long articles of small diameter which might be damaged, or damage the box, if pushed through the ends.

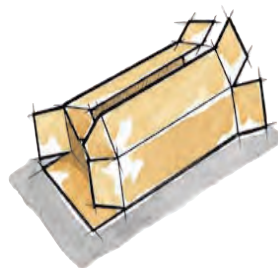
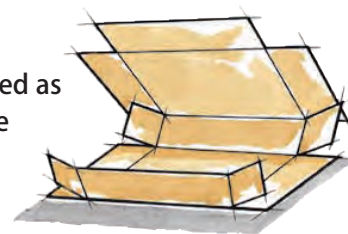

0411 Center Seam FPF

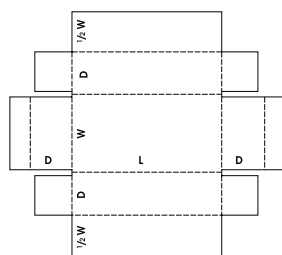
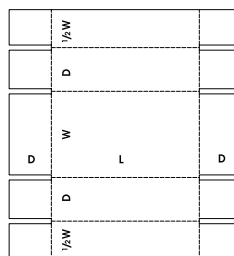

0415 One Piece Folder (OPF) with Dust Flaps

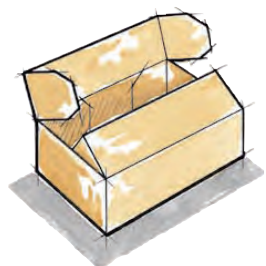
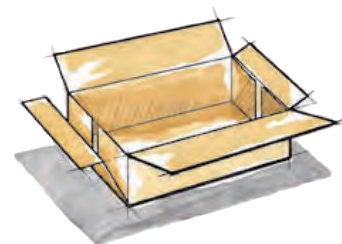

0416 One Piece Folder (OPF), Die Cut with Dust and Tuck Flaps

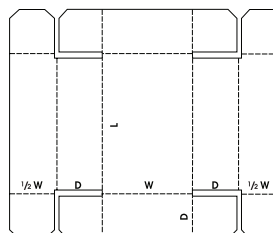

Box Style Reference

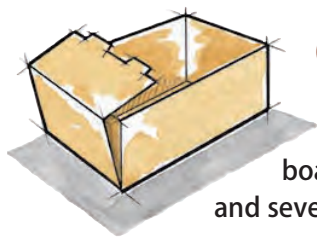

0422 Roll End Tray, Walker Lock Tray, or Tray with Self Locking Ends
Formed from a single piece of combined board, the design features an unbroken bottom, and several layers of corrugated in the end panels.

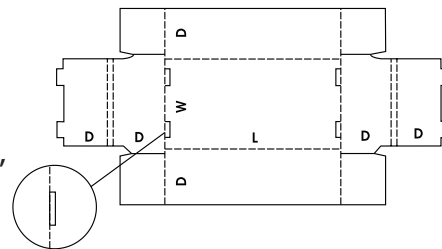

Trays are not shipping containers, but they are frequently used as inner containers for parts, delicate produce, letter mail and other products, or as elements of display stands.

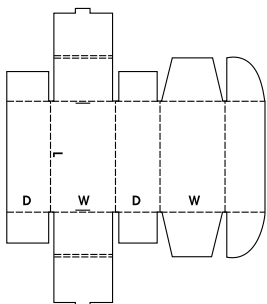

0427 Roll End Tray with Locking Cover

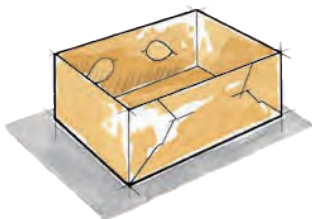
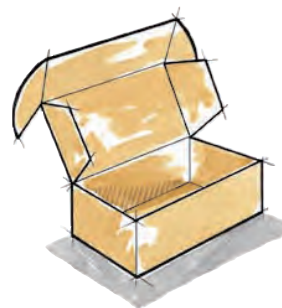

0457 Self Locking Tray, Joint-less Tray

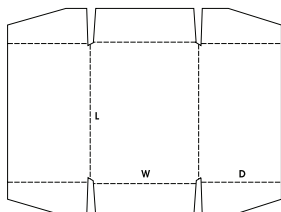
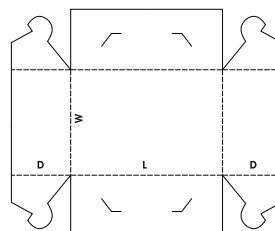

0460 Display Tray or High Wall Tray

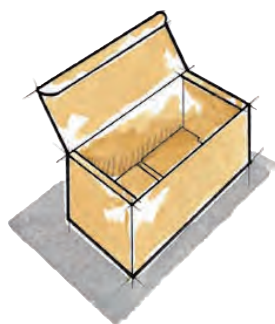
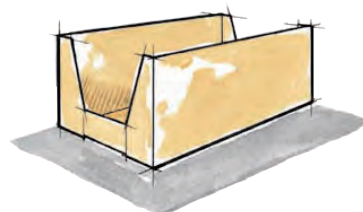

0470 Roll End Tray with Tuck Top and Interior Bottom Flaps or Reverse Walker Lock with Inside Tuck Top

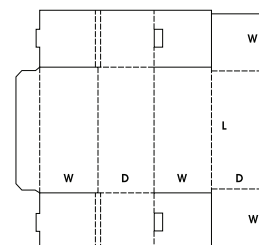

Box Style Reference

4. Rigid Boxes (Bliss Boxes)

The three pieces of a rigid box style include two identical end panels and a body that folds to form the two side panels, an unbroken bottom and the top. Flaps used to form the joints can be on the end pieces or the body or both. The end panels are attached to the body with special equipment, usually at the user's plant. Six or more joints must be sealed to set up the box before it is filled. The name Rigid Boxes comes from the fact that once the six or more joints are sealed, the box is rigid. The International Fibreboard Casecode identifies these styles as Rigid-Type Boxes. In the carrier classifications, rigid boxes are classified as Conventional Slotted Boxes or Recessed End Boxes.



0601A Bliss Style Carton with End Flaps

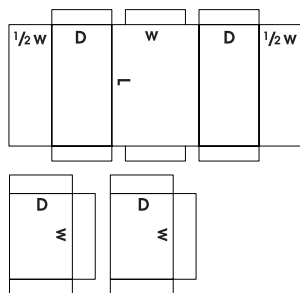
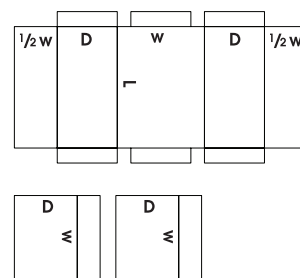

0601B Bliss Style Carton with End Flaps and End Panel Legs



0606A Bliss Style Carton

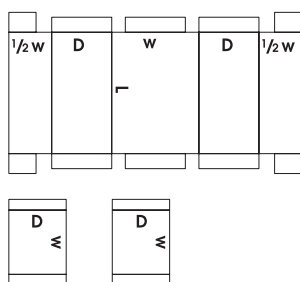
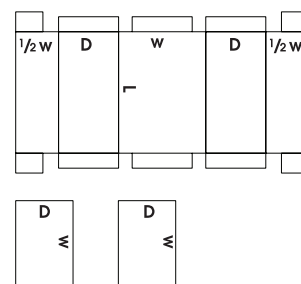

0606B Bliss Style Carton with End Panel Legs



Box Style Reference

5. Self Erecting Boxes

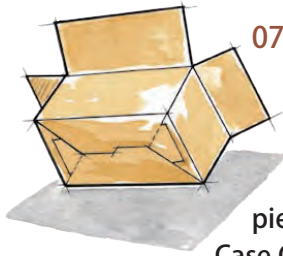

0711 Pre-glued Auto Bottom with RSC Top Flaps

The top panels of the box are usually those of a regular slotted Carton.

For a telescope-style box, two self-erecting pieces can be used (International Fibreboard Case Code: 0714).

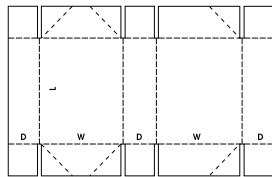
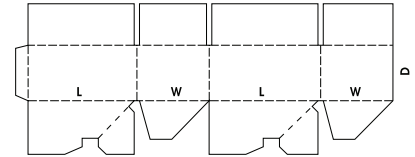

0760 Self Erecting Six Corner Tray



6. Interior Forms

Liners, tubes, pads, build-ups, dividers, partitions and other inner packing pieces can be made in an infinite variety of ways to separate or cushion products, to strengthen the box or to prevent product movement by filling voids. They may be simple rectangles, or scored, slotted, scored and slotted, or die-cut shapes.

Many of the common interior forms have been given International Fibreboard Casecode numbers. The carrier classifications provide specifications for some pieces used in the packing of glassware and other fragile articles.

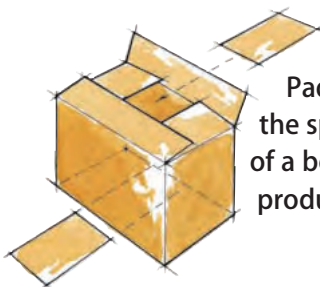

0900 Pads

Pads are plain shapes of corrugated or solid fiberboard. They can be used to fill the space between the inner flaps of an RSC, to completely cover the bottom or top of a box, or to separate layers of product. Vertically, they can be used to separate products.

Box Style Reference

Tubes are scored rectangles, folded and sometimes joined with tape to form a multi-sided structure open at both ends. When used as sleeves for individual items such as glassware, adjacent shells provide double protection.

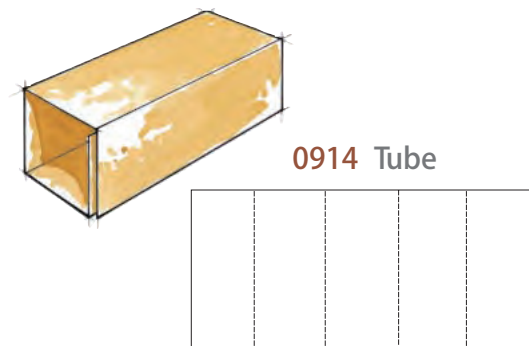
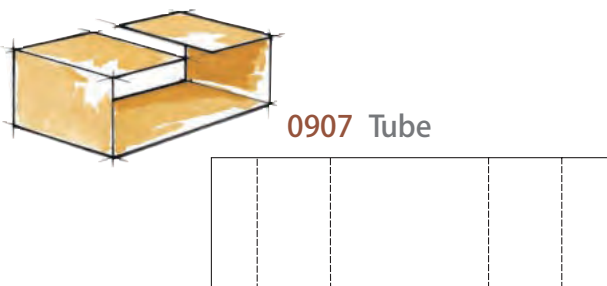
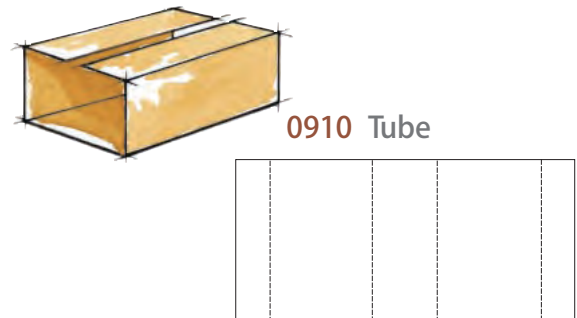
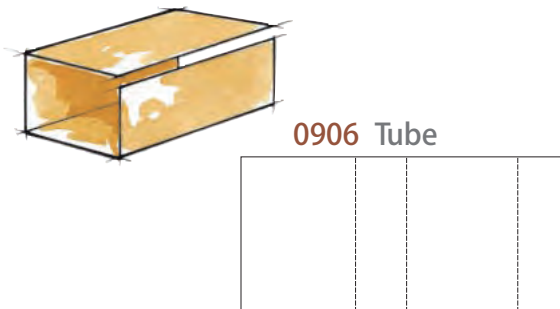
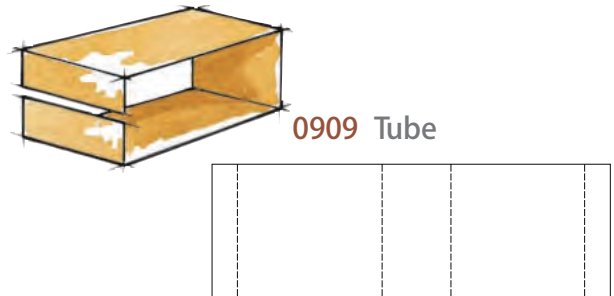
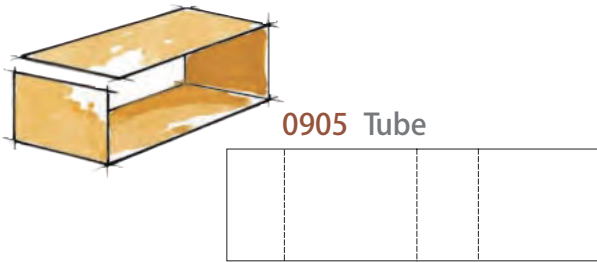

Box Style Reference

Partitions or dividers provide a separate cell for each item in a box. They are used primarily for glassware and other fragile articles.

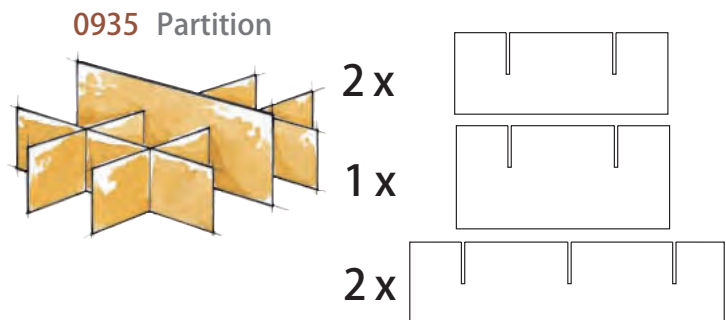
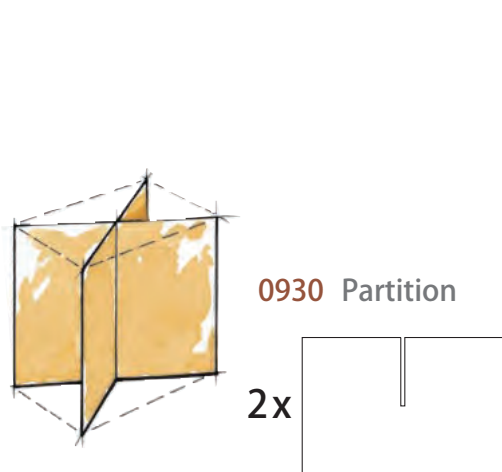
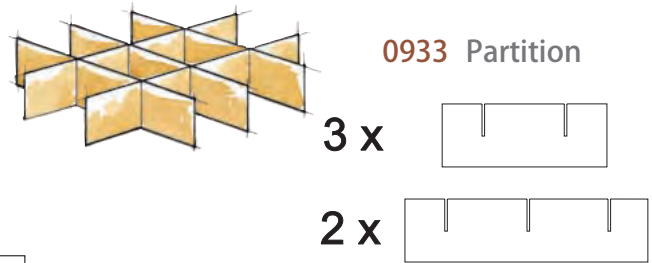
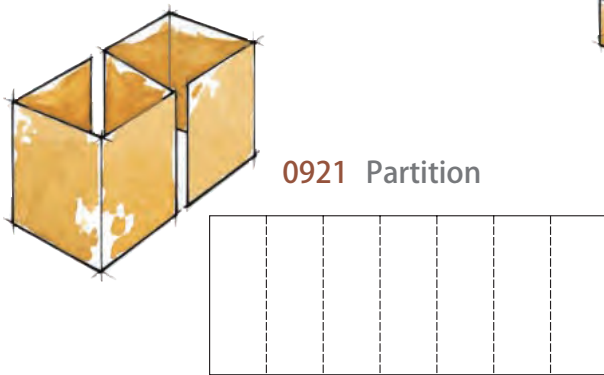
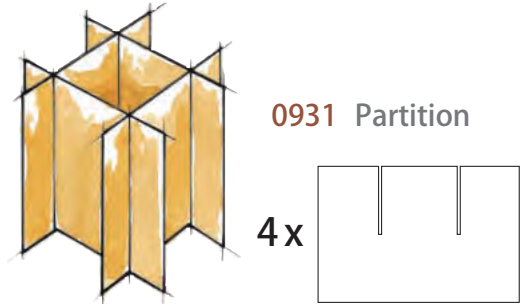
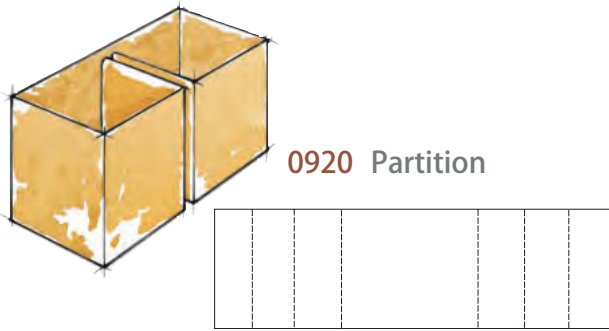

Box Style Reference

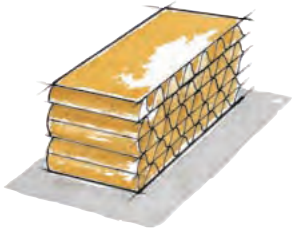

0965 Inner Packing Piece

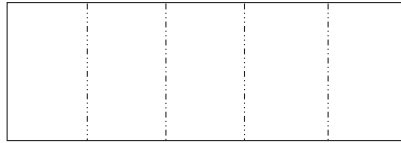

Scored and folded inner packing pieces can take many shapes. Included in this group are built-up pads consisting of multiple pieces glued together. Inner packing pieces are used for cushioning, suspension and separation, and to fill voids. The suspension function holds the product away from the walls of the box to lessen the impact of drops or bumps. Completely filling the voids created by irregularly shaped products adds stacking strength to the box.

0966 Inner Packing Piece

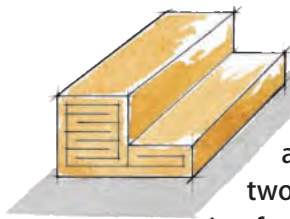
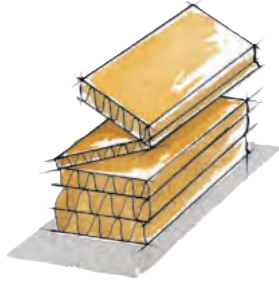
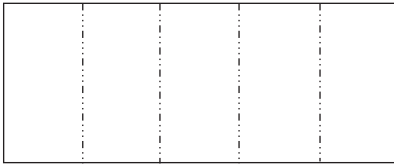

Inner packing forms are usually die cut to position and support irregular products from below, or lock them into position from above. Alternatively, forms can be placed on two sides or ends of a product. Some inner packing forms are extensions of the box flaps.

0967 Inner Packing Form

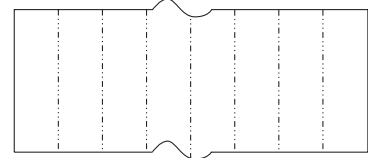

Die-Cut Support Pad
Inner Packing Form

